

Vertical Display and Storage

# SK1000/1300-2

SKOPE Gen2: Two Door Chiller



SK1000/1300-2  
SKOPE Gen2: Two Door Chiller  
User Manual

MAN0970  
Rev. 3.0 Feb. 2008 edition.

Copyright © 2006  
SKOPE Industries Limited.  
All rights reserved.

SKOPE Industries Limited reserve the right  
to alter specifications without notice.

**SKOPE**® is a registered trade mark  
of SKOPE Industries Limited.

## TRADE MARK INFRINGEMENT

The SKOPE trade mark on this product is infringed if the owner, for the time being, does any of the following:

- Applies the trade mark to the product after their state, condition, get-up or packaging has been altered in any manner
- Alters, removes (including part removal) or obliterates (including part obliteration) the trade mark on the product
- Applies any other trade mark to the product
- Adds to the product any written material that is likely to damage the reputation of the trade mark

Notice of the above contractual obligations passes to:

- Successors or assigns of the buyer
- Future owners of the product

# TABLE OF CONTENTS

---

## INSTALLATION

Safety Information . . . . .	4
Positioning the Cabinet . . . . .	5
Fitting the Sign Unit . . . . .	7
Fitting the Shelves . . . . .	8

## OPERATION

Cabinet Operation . . . . .	9
-----------------------------	---

## ELECTRONIC CONTROLLER

Controller Display . . . . .	10
Temperature Setpoint . . . . .	12

## SERVICING

Troubleshooting . . . . .	13
Unit Removal and Refitting . . . . .	16
Cleaning . . . . .	18
Lighting . . . . .	20
Contact Addresses . . . . .	23
Warranty . . . . .	23

# INSTALLATION

---

## Safety Information

When using any electrical appliance, safety precautions should always be observed. Read these instructions carefully and retain for future reference.

- When used by, or near, young children or infirm persons, close supervision is necessary. Young children should be supervised to ensure that they do not play with the appliance.
- Do **NOT** use this appliance for other than its intended use.
- Do **NOT** cover the grilles or block the entry or exhaust of airflow by placing objects up against the refrigeration unit.
- Do **NOT** probe any opening.
- Only use this appliance with voltage specified on the rating label.
- Ensure adequate ventilation of the SKOPE refrigeration unit.
- Be careful not to touch moving parts and hot surfaces.
- Regulations require that all electrical work be carried out by authorised persons. For your own safety, and that of others, ensure this is done.
- If the supply cord becomes damaged, it must be replaced by a SKOPE authorised service agent, or similarly qualified person, in order to avoid a hazard.
- If the refrigeration unit is required to be installed or removed from the cabinet, ensure all necessary safety precautions are observed.
- This chiller is not designed to be stable in motion. Exercise caution when moving or transporting this chiller.

### Warning:

Do NOT overload the power supply. See the rating label inside the cabinet for power supply and current draw.

### Caution:

Disconnect the cabinet from the mains power supply before attempting any cleaning or maintenance.

# INSTALLATION

---

## Positioning the Cabinet

### Location

When positioning the chiller, avoid direct sunlight and warm draughts etc. The cabinet must NOT be situated where it is affected by hot air from adjacent equipment, as this will compromise the airflow and performance of the chiller.

The cabinet must be positioned on a level surface for the doors to shut and seal correctly, and to prevent the condensate tray from overflowing. After final positioning of the cabinet the front castors may be locked to prevent the cabinet moving.

### Installation Guidelines

The maximum recommended ambient temperature (at place of installation) for the chiller is 43°C. This chiller will generally use less power when installed in a cooler location.

When installing the chiller:

- Avoid direct sunlight and warm draughts etc.
- Allow adequate space for the doors to open fully.
- Ensure the cabinet is positioned on a level surface so the doors shut and seal correctly and to prevent the condensate tray from overflowing.
- The self-closing doors have internal torsion bars, pretensioned at the factory, and should not require any further adjustment.
- Do not overload the power supply. See the rating label inside the cabinet for power supply and current draw.

### Power Supply

The chiller is supplied with a 1.8m flexible power cord fitted with a 3-pin plug, which exits out the rear of the refrigeration unit. The power cord should be retrieved before the cabinet is positioned, as wall and partitions may make access difficult.

# INSTALLATION

---

## Ventilation

Adequate ventilation is essential. For efficient operation of the chiller, it is essential that adequate ventilation be provided above the refrigeration unit. Never store cardboard cartons or other items on top of the refrigeration unit. When positioning the cabinet, a gap of at least 200mm must be left above the refrigeration unit..

### **Important:**

To ensure efficient and reliable operation, a minimum of 200mm clear ventilation space is required above the refrigeration unit.

# INSTALLATION

---

## Fitting the Sign Unit

For transit purposes the illuminated sign is packed separately inside the cabinet. To fit the sign assembly to the top of the cabinet:

1. Loosen the four retaining screws on top of the cabinet, and fit both the sign side panels over the screws. Slide the panels forward, flush with edges of cabinet, and tighten the screws.
2. Clip the sign rear panel into the top retaining slots on the rear of the sign side panels (see Figure 1 below).
3. Fit the sign unit by engaging the clips into retaining slots on the front of each side panel.
4. Turn the sign retaining clip, on top of each side panel, and tighten screws to hold sign unit in position (see Figure 2 below).
5. Plug the sign ENSTO 3-pole plug into the left hand end of the unit junction box.

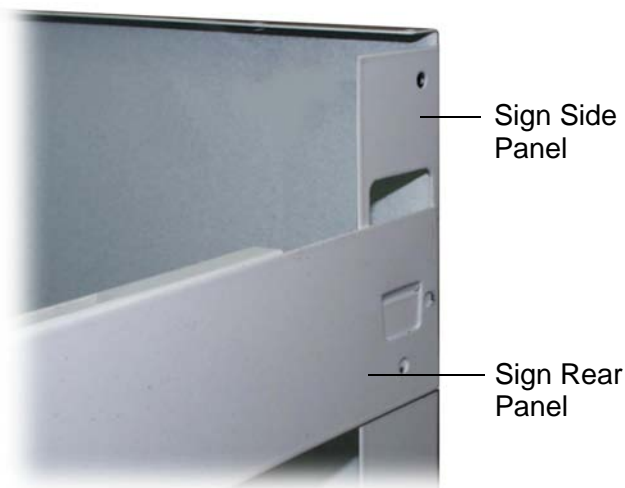

Figure 1: Sign Rear Panel



Figure 2: Sign Retaining Clip

# INSTALLATION

---

## Fitting the Shelves

The chiller is supplied with five layers of shelves, which may be positioned at different heights to suit various products. Depending on the model, each shelf is held in place with either four or six shelf clips, which engage in the shelf support strips. The support strips are marked with a '+' for easy location of shelf clips.

### To fit the cabinet shelves:

1. Unpack the shelves and shelf clips from inside the cabinet.
2. Establish the desired position for the shelves and securely engage a shelf clip in each of the shelf support strips (see Figure 3 below).
3. Sit the shelves onto the shelf support clips.

## Loading Product

The chiller should be left running for 30 minutes before loading with product. When loading the cabinet shelves with product:

- Allow air space around all the product, to ensure even cooling and efficient operation of the chiller.
- Do not allow products to overhang the front of the shelf as this could prevent the doors from shutting or cause glass breakage. Leave an airspace of at least 75mm above product loaded on the top shelf.
- Do not exceed a maximum loading of 195 kg/m<sup>2</sup>
- Remove some product if the shelves are flexing or bending.

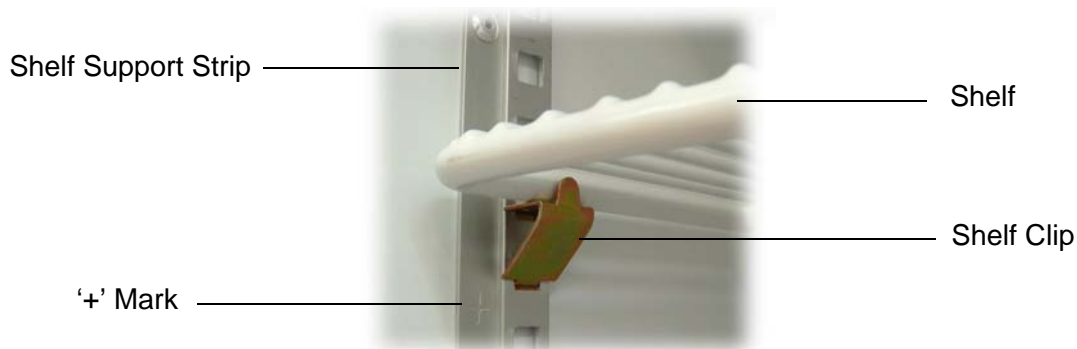

Figure 3: Shelf Clip



# OPERATION

---

## Cabinet Operation

Plug in the cabinet and check operation of the refrigeration unit, electronic controller and cabinet lights.

## Refrigeration Unit

The compressor, as well as evaporator and condenser fans should all operate initially. This may be verified by listening for compressor switch-on, and checking air movement around the refrigeration unit and out of the rear duct inside the cabinet.

The compressor and condenser fan should switch off when the cabinet internal temperature reaches approximately +2°C, and on again at approximately +4°C. The internal cabinet air will continue to circulate at all times.

## Electronic Controller

The electronic controller will either display the internal cabinet temperature or the controller set point. The compressor 'on' icon will indicate that the compressor is operating (see Figure 4 on page 10).

## Cabinet Lighting

The lights which illuminate the top sign and cabinet interior are initially on and will stay on permanently. The lighting will require a period of time to stabilise following initial start up.

# ELECTRONIC CONTROLLER

## Controller Display

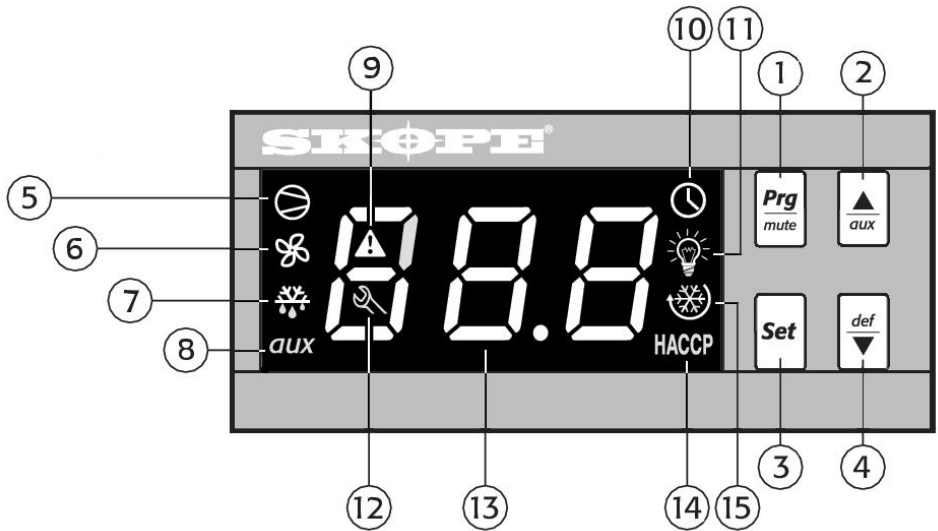

Figure 4: Controller Display

## Keypad

ITEM	KEY	FUNCTION
1		<b>Prg / mute:</b> To initiate programme sets, press for 5 seconds. Mutes the audible alarm (buzzer) and deactivates the alarm relay.
2		<b>UP / aux:</b> To scroll settings <b>UP</b> (in programme mode).
3		<b>Set:</b> If pressed for more than 2 seconds displays and / or enables changing the temperature setpoint (see page 10).
4		<b>DOWN / def:</b> To scroll settings <b>DOWN</b> (in programme mode).

Table 1: Keypad Functions

# ELECTRONIC CONTROLLER

## Icons









ITEM	ICON	FUNCTION
5		<b>COMPRESSOR:</b> ON when the compressor and condenser fan starts. Flashes when activation of the compressor is temporarily delayed.
6		<b>FAN:</b> n.a.
7		<b>DEFROST:</b> ON when the defrost is activated. Flashes when the activation of the defrost is temporarily delayed due to procedures in progress.
8	<i>AUX</i>	<b>AUX:</b> n.a.
9		<b>ALARM:</b> Flashes in the event of alarms.
10		<b>CLOCK:</b> n.a.
11		<b>LIGHT:</b> n.a.
12		<b>SERVICE:</b> Flashes in the event of malfunctions.
13		<b>DISPLAY:</b> Shows the cabinet temperature.
14	<b>HACCP</b>	<b>HACCP:</b> n.a.
15		<b>CONTINUOUS CYCLE:</b> n.a.

Table 2: Icon Functions

# ELECTRONIC CONTROLLER

## Temperature Setpoint

The chiller temperature setpoint is factory set at 1.0°C. If necessary the standard setting can be adjusted between 0.5°C and 3.5°C (see Table 3 below).

SKOPE do not recommend that the setpoint be changed unless it is absolutely necessary, and then only by small increments at a time.

### To View and Adjust the Temperature Setpoint:



	<ol style="list-style-type: none"><li>1. To view the setpoint: press and hold the <b>SET</b> key for 2 seconds, until the setpoint value flashes.</li></ol>
	<ol style="list-style-type: none"><li>2. To adjust the setpoint: press either the <b>UP</b> or <b>DOWN</b> keys to display the required setpoint value.</li></ol>
	<ol style="list-style-type: none"><li>3. Press the <b>SET</b> key again to memorise the new setpoint value. If this is not done within 60 seconds, changes will be lost and you will need to repeat the above procedure.</li></ol>

Table 3: Viewing and Adjusting the Temperature Setpoint

# SERVICING

---

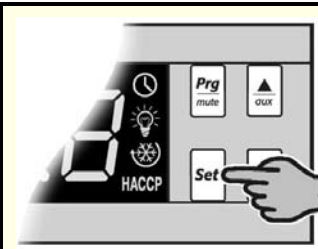
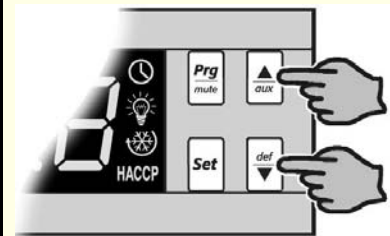
## Troubleshooting

Complaint	Possible Cause	Repair
1. Cabinet not operating and no controller display:	<ul style="list-style-type: none"><li>• Loss of power supply.</li></ul>	<ul style="list-style-type: none"><li>• Check mains power supply.</li></ul>
2. Cabinet lights not operating:	<ul style="list-style-type: none"><li>• Blown cabinet fuse.</li><li>• Failed fluorescent tube.</li><li>• Controller alarm.</li></ul>	<ul style="list-style-type: none"><li>• Requires technical repair by a SKOPE Authorised Service Agent.</li><li>• Check fluorescent tubes.</li><li>• Determine cause and eliminate (see pages 14-15).</li></ul>
3. Power consumption is higher than expected:	<ul style="list-style-type: none"><li>• Unit operating too hot.</li><li>• Cabinet door is opened excessively.</li></ul>	<ul style="list-style-type: none"><li>• Clean condenser. Ensure the chiller is installed with good ventilation around the refrigeration unit.</li><li>• Keep door/s open for minimum time.</li></ul>
4. Product is too warm and spoiling:	<ul style="list-style-type: none"><li>• Restricted cabinet airflow.</li><li>• Temperature setpoint is too warm.</li></ul>	<ul style="list-style-type: none"><li>• Ensure product is not blocking airflow slots and there is air space around all the product.</li><li>• Adjust setpoint (see page 12).</li></ul>
5. Warm cabinet temperatures and/or compressor operating for long periods (more than 1 hour):	<ul style="list-style-type: none"><li>• Blocked condenser.</li><li>• Poor refrigeration unit ventilation.</li></ul>	<ul style="list-style-type: none"><li>• Clean condenser (see pages 18-19).</li><li>• Ensure the cabinet is installed with good ventilation around the refrigeration unit.</li></ul>

Table 4: Troubleshooting

# SERVICING

## Controller Alarms



















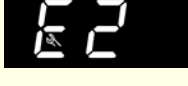

CODE	DISPLAY ICON	ALARM DESCRIPTION
	 Flashing	Product HIGH temperature alarm
	 Flashing	Product LOW temperature alarm
	 Flashing	Refrigeration system high temperature pre-warning
	 Flashing	Refrigeration system high temperature shutdown
	 Flashing	Ambient probe fault
	 Flashing	Evaporator probe fault
	 Flashing	Condenser probe fault
	None	Defrost over-time limit
	 Flashing	Real-time clock fault
	 Flashing	Controller E prom error
	 Flashing	Controller E prom error
	None	Start defrost request
	None	End defrost request

Table 5: Controller Alarms

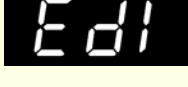
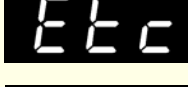
# SERVICING

---

INITIAL ACTION	FINAL ACTION
<ol style="list-style-type: none"> <li>1. Check the cabinet product loading to ensure ventilation slots are not blocked and that product does not overhang the shelves.</li> <li>2. Ensure the cabinet is installed with good refrigeration unit ventilation.</li> <li>3. Check and clean the condenser coil (see pages 18-19).</li> <li>4. Unplug cabinet from the power supply for 1 minute, then reconnect to power supply.</li> </ol>	<p>If alarm persists, contact SKOPE.</p>
<ol style="list-style-type: none"> <li>1. Clean the condenser coil (see pages 18-19).</li> <li>2. Check refrigeration ventilation. Ensure clear airpath at the top and front of the cabinet (to extract hot air). A minimum of 200mm clear space is required in front of the refrigeration unit.</li> <li>3. Ensure the cabinet is installed in a suitable environment.</li> <li>4. Unplug cabinet from the power supply for 1 minute, then reconnect to power supply.</li> </ol>	
<p>Unplug cabinet from the power supply for 1 minute, then reconnect to power supply.</p>	
<p>None</p>	<p>None</p>

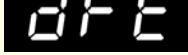
# SERVICING

## Unit Removal and Refitting

The SKOPE Cyclone refrigeration unit can easily be removed from the top of the cabinet for transporting and moving the cabinet through doorways etc.

**To remove the refrigeration unit:**

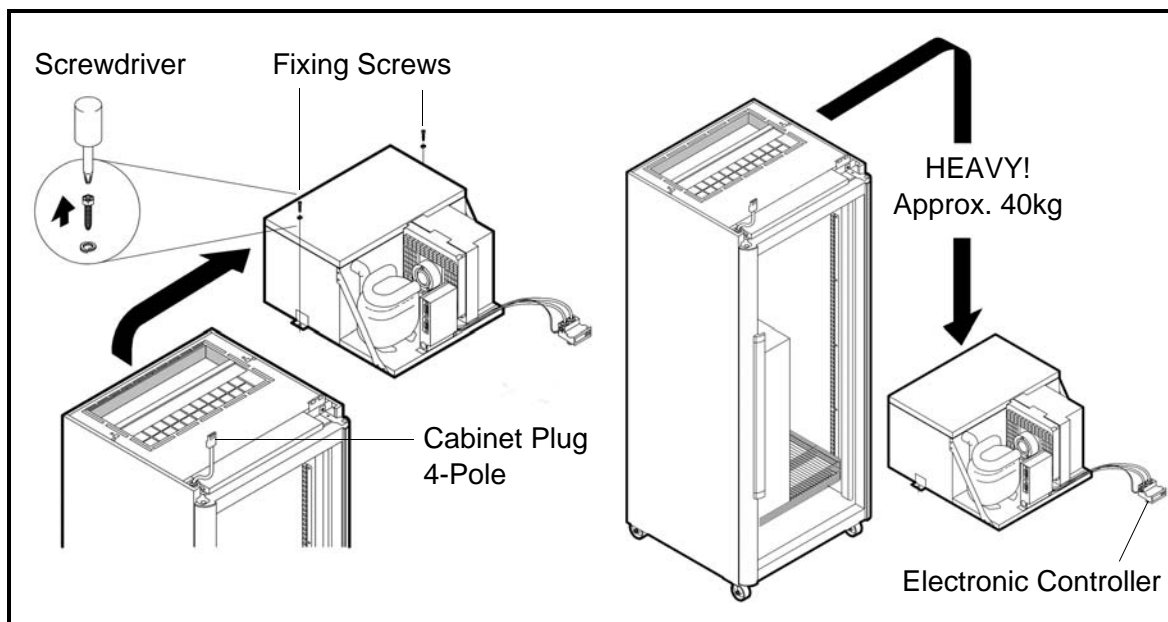
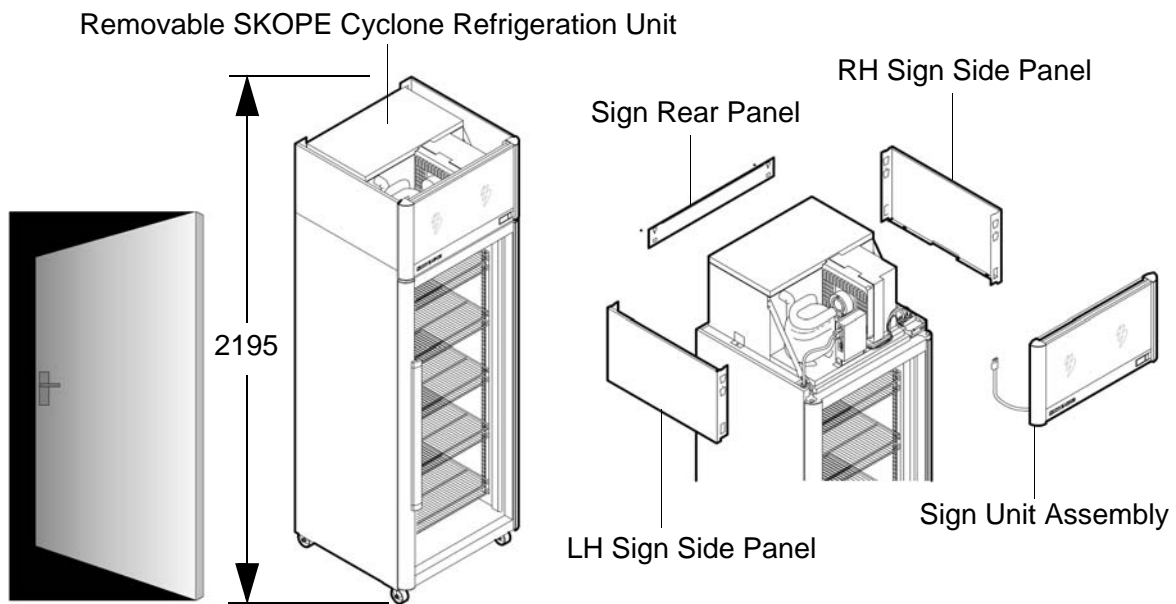



# SERVICING

---

To refit the refrigeration unit:

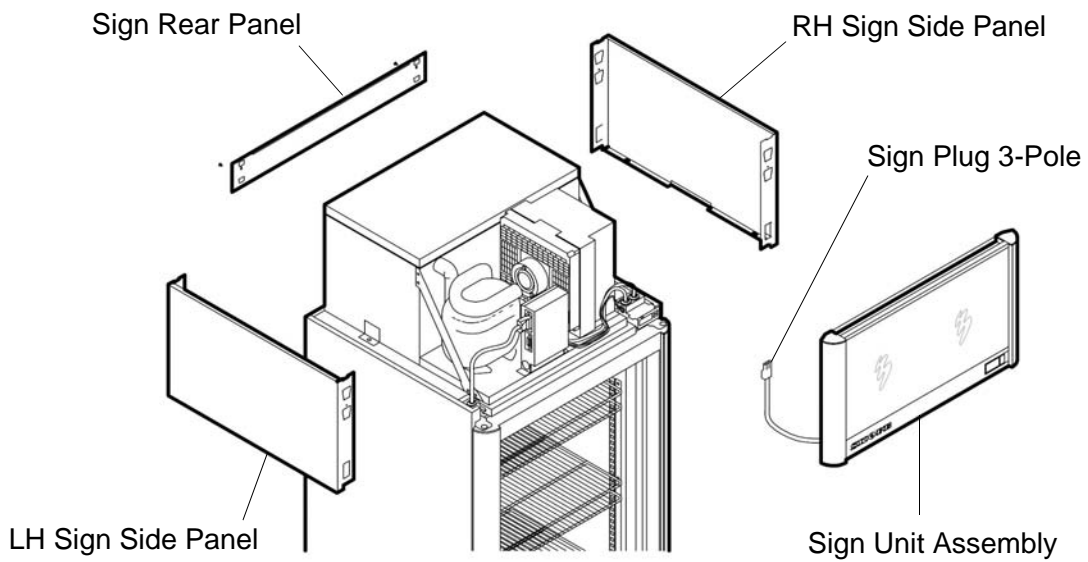
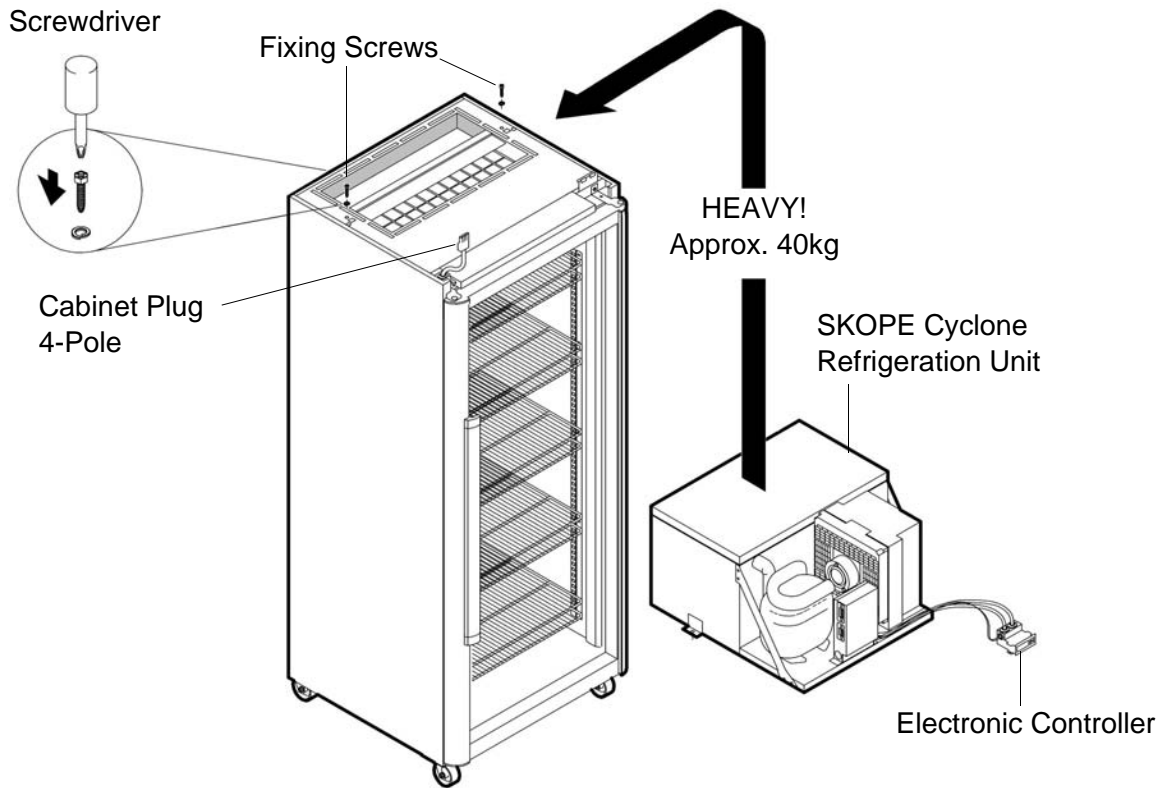

# SERVICING

---

## Cleaning

When necessary, wipe both the interior and exterior of the cabinet with a damp cloth. Ensure the cabinet is disconnected from the mains power supply before cleaning the cabinet. Periodic cleaning of the condenser coil is also recommended.

## Condenser Coil

The condenser coil is situated behind the sign unit. The condenser coil **MUST** be kept clean for reliable operation and to minimise power consumption (a blocked condenser can double power consumption).

To ensure trouble free performance, the condenser coil should be brushed clean once a month (see Figure 5 on page 19) and blown clean by qualified service personnel every six months. If the electronic controller display flashes '**cht**' the condenser coil immediately needs cleaning.

Over time, dust may accumulate within the condenser that cannot be removed with a brush. If this occurs, contact SKOPE to arrange for a SKOPE Authorised Service Agent to clean the condenser with compressed air.

### **Warning:**

If the electronic controller display flashes '**cht**' the condenser coil must be cleaned immediately.

### **To access the condenser coil:**

1. Disconnect the cabinet from the mains power supply.
2. Disconnect the sign plug from the electrical box socket and remove the sign unit from the cabinet (see page 9).
3. The condenser coil is now accessible for cleaning (see Figure 5 on page 19).
4. See page 7 for instructions on re-fitting the sign unit.

### **Caution:**

Disconnect the cabinet from the mains power supply before attempting any cleaning or maintenance.

# SERVICING

---

## Condenser Coil

For optimum performance, ensure that the condenser coil is regularly cleaned. Repairs to the chiller that are either under warranty, lease or provided by a third party, may be on-charged to the user if the fault is found to be caused by a lack of maintenance.

### **Important:**

For optimum performance, ensure that the condenser coil is regularly cleaned.

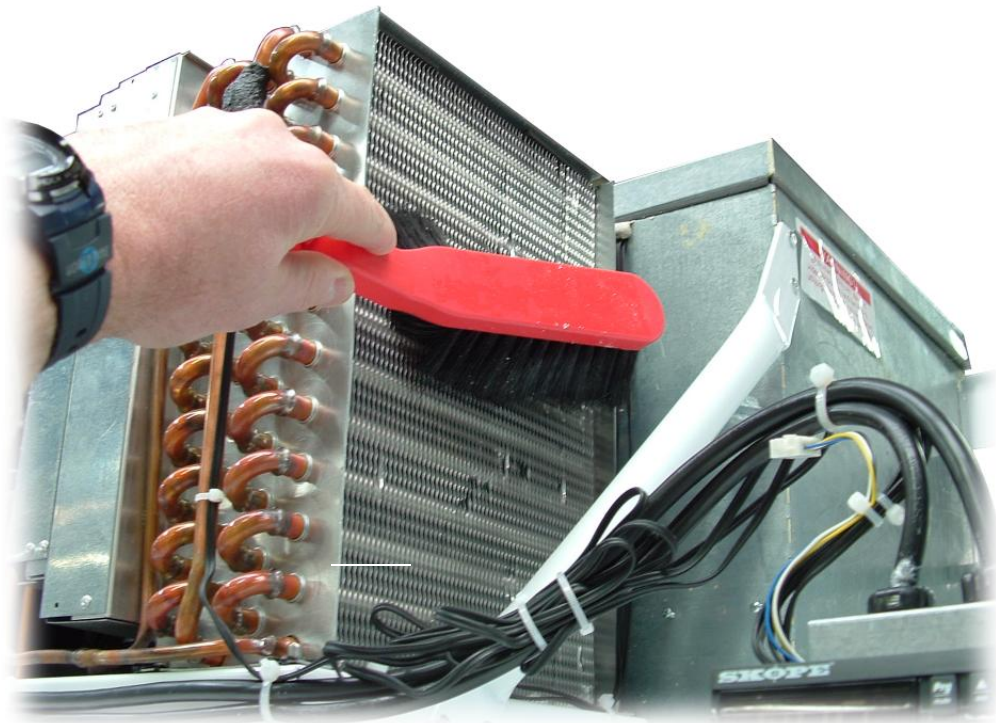

Figure 5: Cleaning the Condenser Coil

# SERVICING

---

## Lighting

### Cabinet Sign Unit

The cabinet sign unit is fitted with fluorescent lighting. See the chart below for the correct fluorescent tube size:

Model	Fluorescent Tube
SK1000-2	1 x 21 Watt T5 fluorescent tube (Ø16mm x 850mm)
SK1300-2	1 x 28 Watt T5 fluorescent tube (Ø16mm x 1150mm)

To replace a fluorescent tube:

1. Disconnect the cabinet from the mains power supply.
2. Remove the sign panel by starting at one of the top corners and pulling the sign panel out from under the sign top cover (see Figure 6 below).
3. The fluorescent tube can now be removed. Revolve the tube until the pin position allows withdrawal (see Figure 7 below).
4. When refitting the sign panel, ensure the panel engages into the sign top along the full length of the sign unit and both the sign end strips fit neatly into the top and bottom corner notches.

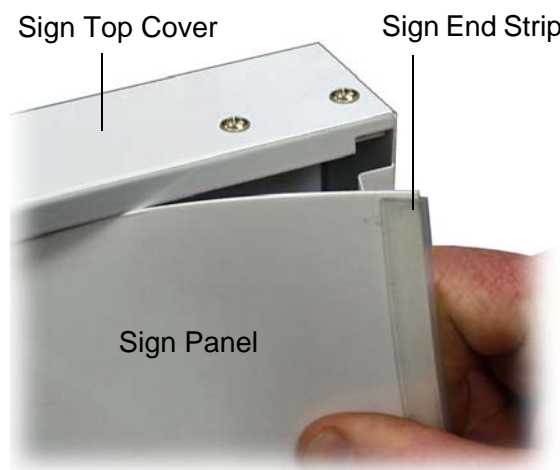

Figure 6:  
Removing Sign Panel

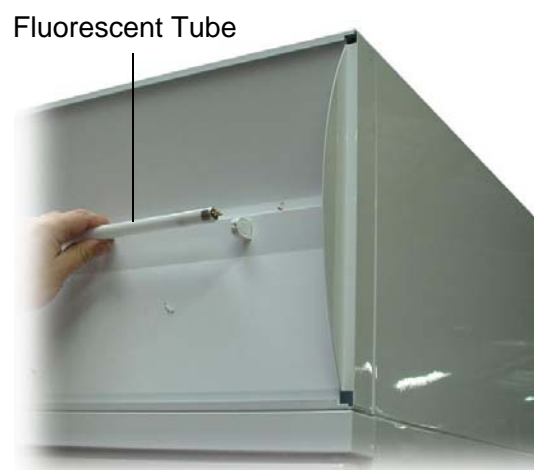

Figure 7:  
Replacing the Fluorescent Tube

# SERVICING

---

## Cabinet Interior Lights

The cabinet interior side lights are each fitted with one 35 Watt T5 fluorescent tube (Ø16mm x 1450mm, Daylight 840), which may be replaced without removing shelves or product from the cabinet. To replace the fluorescent tube:

1. Disconnect the cabinet from the mains power supply.
2. Remove the side light diffuser, by compressing the back section of the diffuser until it disengages from the aluminium housing and then push the diffuser back (see Figure 8 below).
3. The fluorescent tube can now be removed. Revolve the tube until the pin position allows withdrawal.
4. When refitting the new fluorescent tube ensure the printing on the tube is at the bottom, as the tube orientation is important. The replacement tube must be of the same wattage and colour rendering as the original.
5. When refitting the diffuser, engage the back section into the housing and then compress and snap the front section of the diffuser into place, working down the full length of the housing.

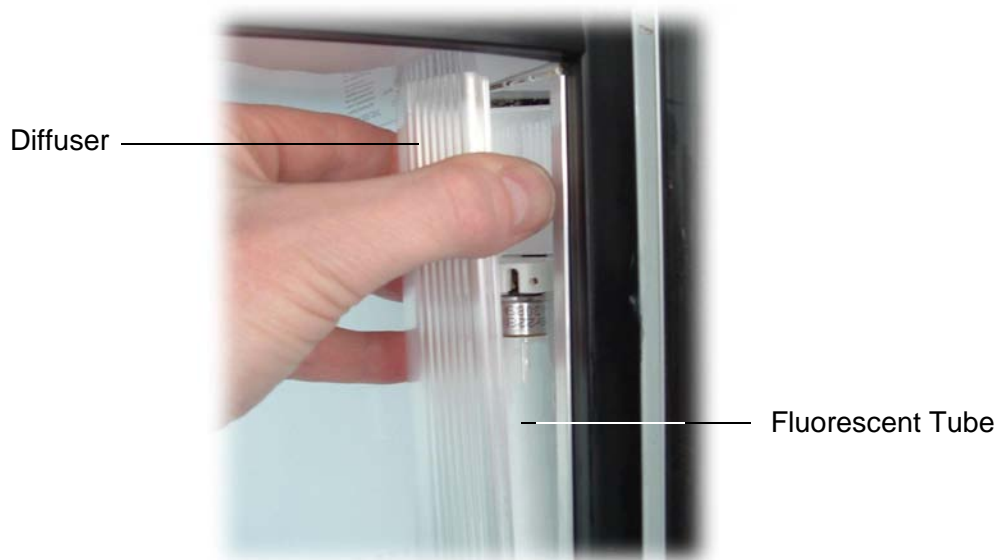

Figure 8: Cabinet Interior Light

# SERVICING

---

## Centre Pillar Light

The centre pillar light is fitted with one 35 Watt T5 fluorescent tube (Ø16mm x 1450mm, Daylight 840). To replace the fluorescent tube:

1. Disconnect the cabinet from the mains power supply.
2. Remove the centre pillar diffuser by compressing both sides of the diffuser so that it disengages from the pillar housing (see Figure 9 below).
3. The fluorescent tube can be removed, by revolving the tube until the pin position allows withdrawal.
4. When refitting the new fluorescent tube ensure the printing on the tube is at the bottom, as the orientation of the tube is important. The replacement tube must be of the same wattage and colour rendering as the original.
5. To refit the diffuser, engage one side of the diffuser into the pillar housing and compress and clip the diffuser back into place working down the full length of the housing.

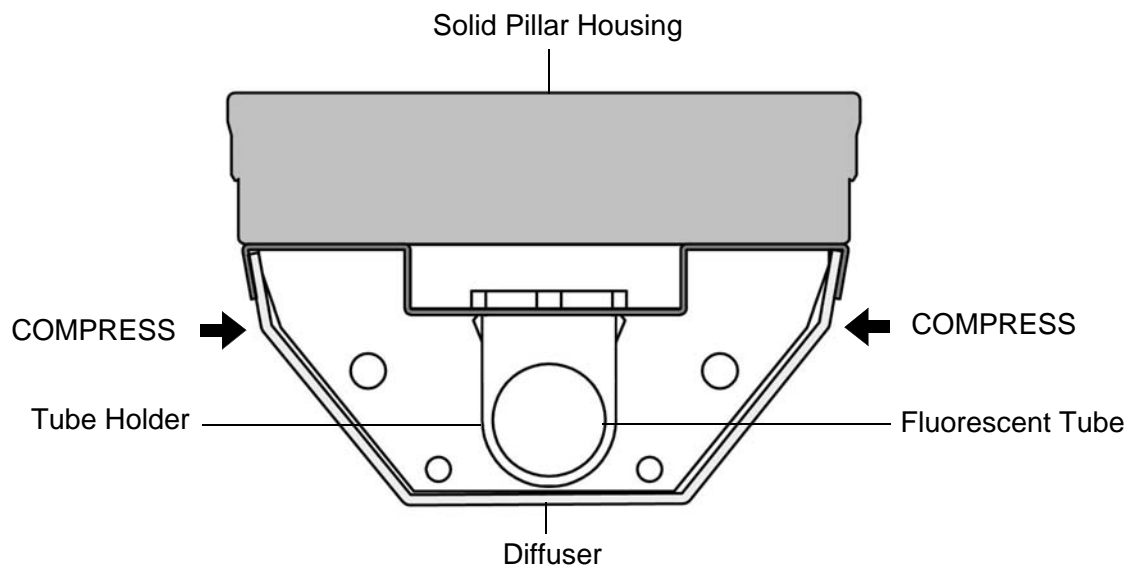

Figure 9: Centre Pillar Light

# SERVICING

---

## Contact Addresses

### New Zealand

#### SKOPE INDUSTRIES LIMITED

Head Office

PO Box 1091, Christchurch

New Zealand

Freephone: 0800 947 5673

Fax: (03) 983 3896

E-mail: [enquiry@skope.co.nz](mailto:enquiry@skope.co.nz)

Website: [www.skope.co.nz](http://www.skope.co.nz)

### Australia

#### SKOPE AUSTRALIA PTY LTD

A.C.N. 000 384 270

PO Box 7543, Baulkham Hills B.C.

NSW 2153, Australia

Freephone: 1800 121 535

Fax: 1800 121 533

E-mail: [enquiry@skope.com.au](mailto:enquiry@skope.com.au)

Website: [www.skope.com.au](http://www.skope.com.au)

## Warranty

To receive a warranty for your purchased cabinet, you **MUST** register your cabinet within four weeks from the date of invoice either by:

- filling out the in-cabinet warranty form and posting or faxing it back to SKOPE
- or filling out the online warranty form.

Cabinets that are not registered within the four weeks are not eligible for a warranty.