

Coolroom Specifications:	
Width (mm):	2550
Depth (mm):	2550
Height (mm):	2150

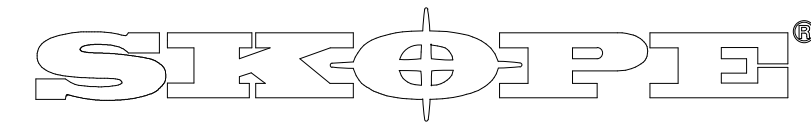
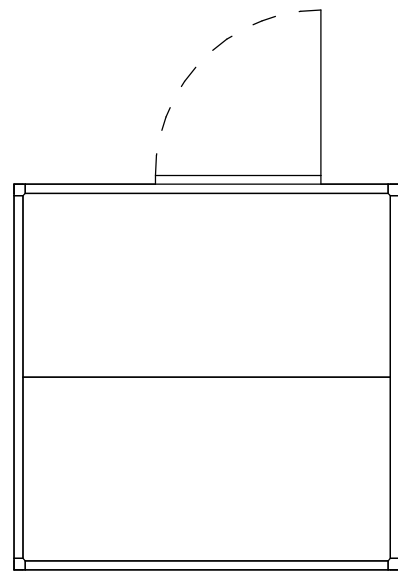
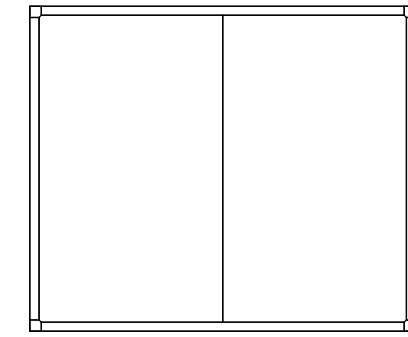
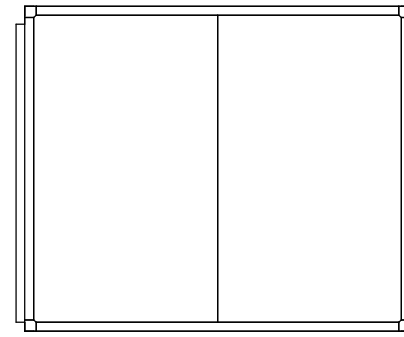
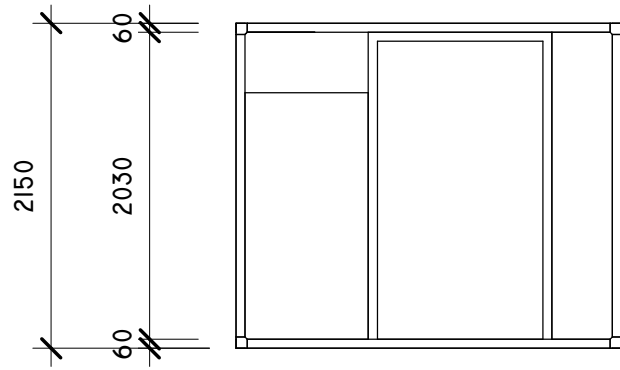
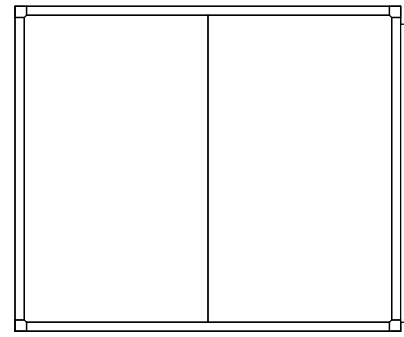
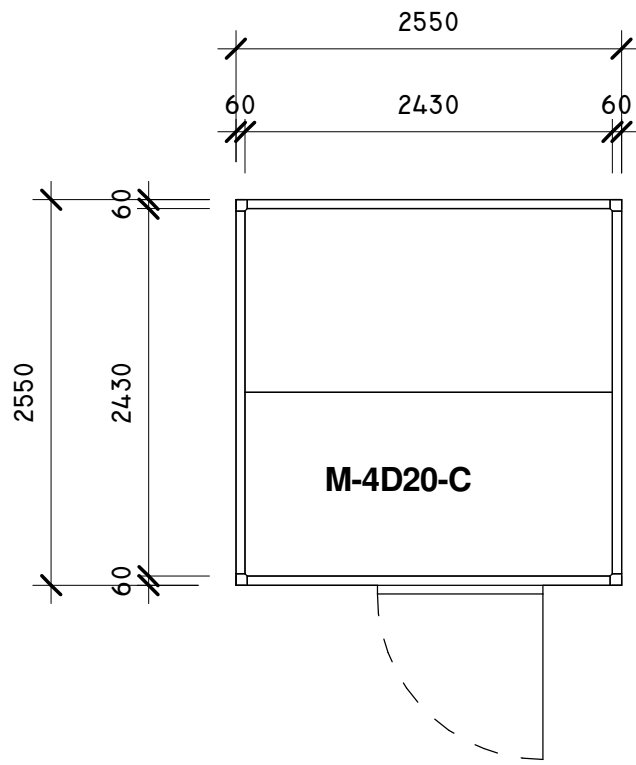

Industries Limited

66 Princess St. PO Box 1091
 Christchurch, New Zealand
 New Zealand Freephone: 0900 947 5673
 Australian Freephone: 1800 121 535
 Email: enquiry@skope.co.nz
 Website: www.skope.co.nz

Model: M-4D20-C	
Description: Chiller Room, 11.99m3, S6 panel incl Floor	
Unless Otherwise Specified:	Scale
Folded Dimensions: Overall	1:50
Linear Tolerances: +/- 0.5mm	
Angular Tolerances: +/- 0.5mm	
Units: Millimetres	Revision
	-.-
Copyright © SKOPE Industries Limited	