

OD460

SKOPE Open Deck Chiller



CONTENTS

1	Installation	
	Safety First	4
	Positioning the Cabinet	5
	Climate Class	5
	Chiller Location	5
	Air Movement	5
	Power Cord	5
	Ventilation	5
	Shelves	7
	Installing the Shelves	7
	Optional Gravity Shelf System	8
2	Operation	
	Automatic Start-Up	9
	Lights	9
	Night Blind	9
	Loading Product	10
	Electronic Controller	11
	Introduction	11
	Day and Night Modes	11
	Faceplate	12
	Defrost	13
	Continuous Cycle	13
	Temperature Setpoint	14
	Controller Reset	14
	Controller Alarms	15
3	Maintenance	
	Isolating Electrics	16
	Maintenance	17
	Troubleshooting	18

1 Installation

Safety First Always observe safety precautions when using any electrical appliance. Read these instructions carefully and retain them for future reference.

- When the appliance is used by or near young children or infirm persons, close supervision is necessary, especially to ensure children do not play with it.
- Do **not** use this appliance for other than its intended use.
- Do **not** cover the grilles or block the entry or exhaust of airflow by placing objects up against the refrigeration unit.
- Do **not** probe any opening.
- Only use this appliance with the voltage specified on the cabinet rating label.
- Ensure the chiller has adequate ventilation as this is essential to economical, high performance.
- Be careful not to touch moving parts and hot surfaces.
- For your own safety and that of others, ensure that all electrical work is done by authorised personnel.
- If the power supply flexible cord becomes damaged, it must be replaced by an authorised service agent or similarly qualified person in order to avoid a hazard.
- Ensure all necessary safety precautions are observed during installation or removal of the refrigeration unit.
- The chiller is not designed to be stable while in motion. Use extreme caution when moving or transporting it.
- Do not store explosive substances such as aerosol cans with a flammable propellant in this appliance.
- Please contact SKOPE Customer Services for advice regarding disposal of this appliance.

WARNING

Disconnect the cabinet from the mains power supply before attempting any cleaning or maintenance.

CAUTION

Never overload the power supply, which could damage the chiller and product. See the rating label inside the cabinet for the safe power supply and current draw.

CAUTION

Do **NOT** allow liquids or any other materials to drain into the bottom of the cabinet, as this could lead to refrigeration system failure.

Positioning the Cabinet

Climate Class The OD460 chiller is designed to operate within a climate class 3 environment (25°C @ 60% RH). We recommend that you put the chiller in the coolest place possible because it will use less power and last longer.

Chiller Location The location of the chiller may be the single most important decision that will extend its life and ensure economical, high performance. Ensure the cabinet is placed where it is not exposed to drafts or direct sunlight. The cabinet must sit on a level surface to prevent the condensate tray from overflowing.

Air Movement The cabinet must **NOT** be situated where it is affected by air-conditioning air outlets, ventilation fans or air re-circulation fans, as this will compromise the airflow and thus product temperature in the open cabinet zone.

There must be **NO** air movement directly into the cabinet opening. Air movement will cause failure of the air curtain over the product, resulting in excessive temperature rise. Detectable air draft will adversely effect the cabinet operation. Maximum air movement across the cabinet opening must not exceed 0.2 m/s.

IMPORTANT

There must be **NO** air movement directly into the cabinet opening.

Power Cord The cabinet has a flexible power cord fitted with a 3-pin plug, which exits the rear of the cabinet at floor level. Locate the power cord before the cabinet is moved into position so that it is not trapped behind the cabinet.

The cabinet must have its own dedicated power supply. Multi-plug connecting boxes and extension cords must not be used. Check the cabinet does not overload the power supply (see the rating label inside the cabinet for current draw).

Ventilation Adequate ventilation must be provided around the refrigeration unit and cabinet at all times. Refrigeration exhaust air must not be restricted, and must be able to easily flow out and away from the cabinet.

Ensure there is unimpeded clearance in front of the kick panel at all times. Never store cardboard cartons or other items in the front or rear of the refrigeration unit.

CAUTION

Ensure adequate ventilation clearance around the refrigeration unit and cabinet.

Determine if the installation is free-standing or enclosed, and ensure the installation meets the ventilation requirements detailed below.

Free-standing installations

Free-standing cabinets must be installed with the following minimum clearances:

- 30mm behind (provided by the rear spacers on the back of the cabinet).
- 60mm on either side of the cabinet.
- 200mm above the cabinet.

If these clearances can't be met, the installation should be treated as an enclosed installation.

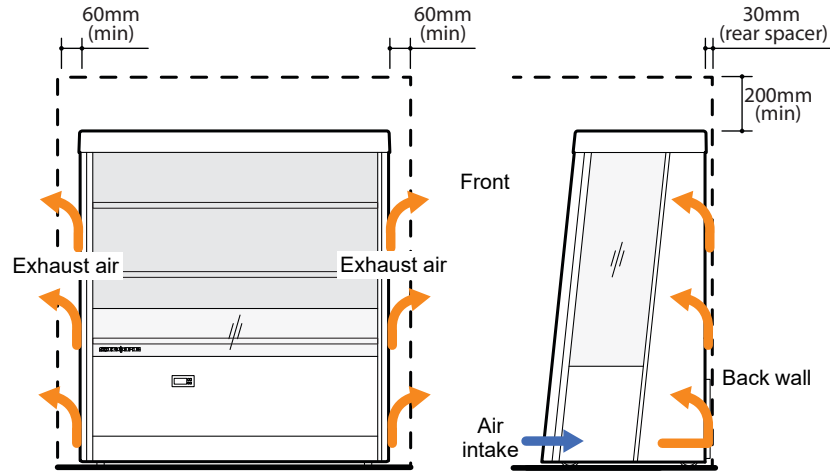

Free-standing installation ventilation requirements

Enclosed installations

Enclosed installations must have the following minimum clearances around the cabinet, and include the following features:

- 75mm behind the cabinet.
- An air guide must be used to ensure all refrigeration exhaust air is directed up and away from the cabinet.
- The air guide must also ensure the air exhaust outlet cannot be blocked by product or other items above the cabinet.

Refrigeration exhaust air must **NOT** be allowed to run horizontally across the top of the cabinet, as it may be pulled down into the cabinet interior.

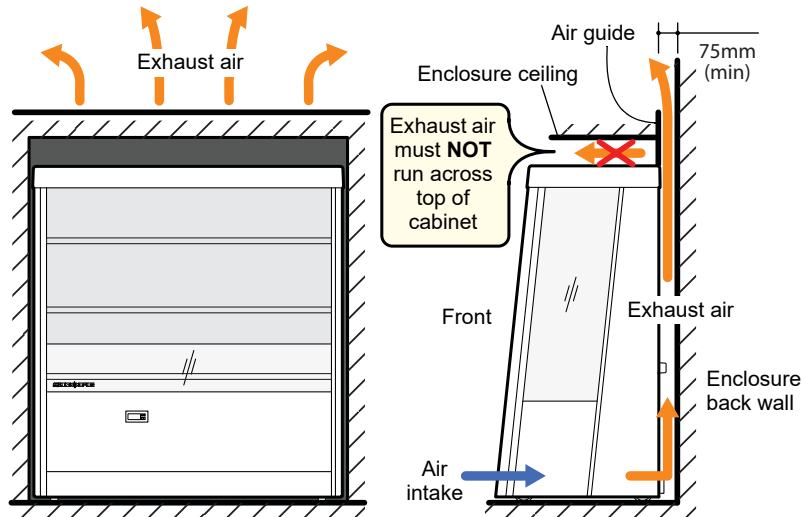

Enclosed installation ventilation requirements

Shelves

Installing the Shelves The chiller is supplied with three metal shelves. The shelves are different depths, with the top shelf being the shallowest and the bottom shelf the deepest. The bottom shelf is fixed in position, and the two top shelves are height and angle adjustable, and removable.

The two top shelves are each held in place by two cantilevered shelf brackets which clip into cut-outs in the cabinet back duct. Further 6mm interval height adjustments can be made by separating the shelf bracket into two parts and re-slotting together using the alternative slots (see image below).

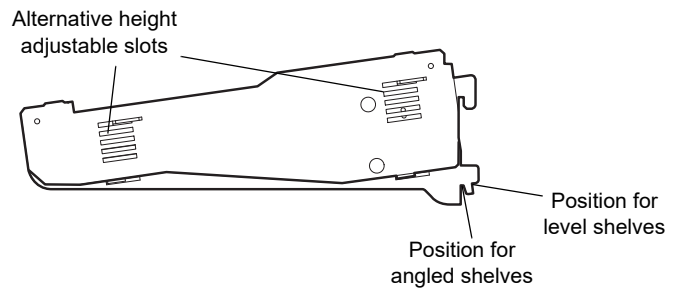

To fit the shelves

1. Clip the cantilevered shelf brackets into the slots in the cabinet back duct.

Use the different positions on the bracket to set the shelf angled or level (see image above).

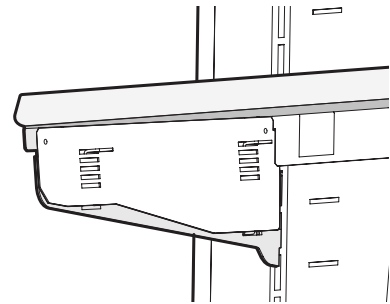

2. Sit the corresponding metal shelf on the cantilevered brackets ensuring the back of the shelf clips over the rear of the brackets.

3. Push the cantilevered brackets outwards until they clip into the edge locating slots on the side of the shelf.

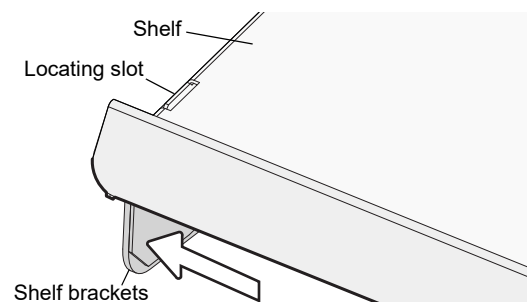

Optional Gravity Shelf System When the chiller is ordered with the optional gravity feed matting, each shelf is supplied with corresponding gravity feed matting and shelf dividers. The gravity shelf system comes in three sizes to suit the three different size shelves.

To fit the gravity feed matting and shelf dividers

1. Match up the shelf dividers with the corresponding mats.

 2. Starting from the LH or RH side of the mat, fit the LH or RH end divider into the end row of slots.

 3. Work across the matting and fit the centre dividers at required intervals, then fit the opposite end divider.

 4. Slide the ticket strip across the front of the mat.

 5. Place the mat and dividers onto the corresponding shelf inside the chiller.

 6. Repeat for the remaining shelves.
-
-

2 Operation

Automatic Start-Up

After the cabinet has been positioned in a suitable place, plug it in and check the following activity.

Item	Activity
Electronic controller	An electronic controller runs the chiller and is visible behind the front panel. The display panel first flashes start-up messages before stabilising on the cabinet temperature.
Lighting	If the night blind is up, the lights that illuminate the cabinet interior will come on a few seconds after the chiller is turned on. The lights are off when the night blind is down.
Refrigeration unit	The refrigeration unit evaporator and condenser fans should all operate continuously from the time the cabinet is plugged in. This may be verified by checking for air movement inside the cabinet. The internal cabinet air will continue to circulate at all times. The compressor will start after approximately one minute, will switch off when the cabinet internal temperature reaches approximately +1.5°C and on again at approximately +4°C.

Lights

The chiller is fitted with interior LED lights. The lights turn off and on automatically when the chiller is switched between Night and Day mode (via night blind or electronic controller button, see “Day and Night Modes” on page 11). The lights can also be switched on and off manually without changing the chiller between night and day mode by pressing the light button on the electronic controller faceplate (see “Faceplate” on page 12).

Lighting components must not be tampered with in any way. If a unit is suspected of being faulty, a service call should be arranged so that a replacement component can be fitted.

Night Blind

The chiller is fitted with a manual night blind which should be pulled down into the closed position during store closing hours to save power. The night blind has a switch which automatically tells the electronic controller to run the chiller in Night mode (with the lights OFF) when the blind is in the closed position or Day mode (with the lights ON) when in the open position.

The night blind is located at the top of the cabinet opening and is not visible when in the open position.

To close the night blind, use the handle to pull the blind down and hook it under the night blind retaining brackets at the bottom of the chiller opening. To open, use the handle to release the blind from the retaining brackets and control the blind as it opens.

Loading Product

Let the chiller run for 30 minutes before loading it with product for the first time. When loading the cabinet shelves with product:

- Allow adequate air space around each item to ensure even cooling and efficient operation of the chiller.
- Remove some product if the shelves are flexing.
- Do not exceed maximum shelf loadings:

Shelf	Maximum weight
Top shelf	27.5 kg
Middle shelf	35.0 kg
Bottom shelf	40.0 kg

- Do not load product over the return air grille.
- Do not allow products to overhang the front of the shelves, as this will affect the air flow.

Electronic Controller

Introduction The OD460 chiller is fitted with a Carel ir33 electronic controller which is visible through a cut-out in the cabinet front panel.

The electronic controller switches the chiller between Day and Night modes depending on the night blind position, and uses temperature probes to control and display the chiller temperature, collect data, signal temperature alarms and force a defrost cycle when required.

The electronic controller is pre-programmed and requires no initial setup or additional programming. SKOPE does not recommend that the settings be changed unless it is absolutely necessary.

CAUTION

The electronic controller must only be adjusted by an authorised service agent.

Day and Night Modes The electronic controller will automatically switch the chiller between Day and Night modes depending on the night blind position. When the blind is in the open (up) position, the chiller runs in Day mode. When the blind is in the closed (down) position, the chiller runs in Night mode.









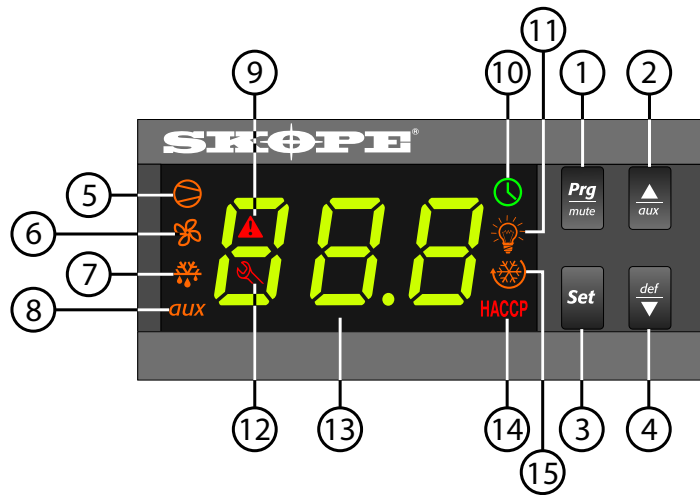



During Day mode, the lights are ON and the chiller keeps product at required (cool) temperature for serving, and the chiller temperature is displayed on the controller display.

During Night mode, **nHt** is displayed on the controller display, the lights are OFF and the chiller slightly elevates the product temperature to achieve higher energy efficiency during store closing hours.

Note: The chiller is suitable for storage of perishable products in either Day or Night modes (all shelves maintain temperatures below 5°C).

Faceplate Because the electronic controller plays such an important role, it's helpful to know the parts of the faceplate you may use.



No.	Item	Description
1		Mute (program): Button. Mutes the audible controller alarm. Also used for controller programming.
2		Aux (up): Button. Press and hold to switch the lights on and off. Also used for controller programming.
3		Set: Button. Service use only. Used for controller programming
4		Defrost (down): Button. Press and hold to initiate a manual defrost cycle. Also used for controller programming.
5		Compressor: Indicator. On when the compressor and condenser fan are running. Flashes when activation of the compressor is temporarily delayed.
6		Fan: Indicator. On when the fans are operational.
7		Defrost: Indicator. On when a defrost cycle is activated. Flashes when the activation of the defrost is temporarily delayed due to procedures in progress.
8	aux	Aux: n.a.
9		Alarm: Indicator. Flashes in the event of alarms.
10		Clock: Indicator. On when real time clock is enabled.
11		Light: Indicator. On when the cabinet lighting is activated.
12		Service: Indicator. Flashes in the event of malfunctions.
13		Display: Indicator. Digital display of cabinet temperature or alarms. Displays nHt during night mode. The temperature is what the sensor inside the chiller detects, and not necessarily the product temperature. However, they may be very close depending on how the controller is set to sense temperature.
14	HACCP	HACCP: n.a.
15		Continuous Cycle: Continuous cycle in progress (see page 13).

Defrost To ensure efficient operation, the electronic controller forces a defrost cycle when required. During a defrost cycle, the compressor stops, **DEF** and the ❄️ will display on the electronic controller faceplate. The cabinet will resume normal operation once the defrost cycle has finished. A manual defrost can also be initiated by pressing and holding the $\frac{def}{\nabla}$ button.

Continuous Cycle The continuous cycle can be used to pull down the temperature of product inside the cabinet quickly. During a continuous cool down the compressor runs continuously for a set time.

To start a continuous cycle

1. While the cabinet is switched on and running, press and hold the $\frac{\blacktriangle}{aux}$ and $\frac{def}{\blacktriangledown}$ buttons for five seconds.

The ❄️ symbol will display during a continuous cycle.

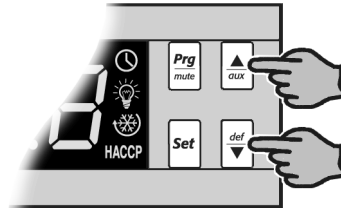

To stop a continuous cycle

1. The electronic controller will automatically stop the continuous cycle after a period of time.

The continuous cycle can be stopped by pressing and holding the $\frac{\blacktriangle}{aux}$ and $\frac{def}{\blacktriangledown}$ buttons for five seconds.

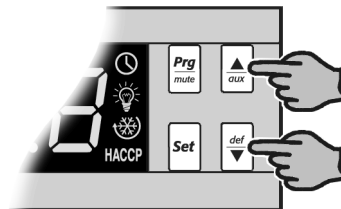

Temperature Setpoint

The chiller is manufactured with a pre-set control temperature set point which can be adjusted if required. SKOPE do not recommend that the set point be changed unless absolutely necessary.

To view and adjust the temperature setpoint

1. To view the setpoint: press and hold the **Set** key for 2 seconds, until the setpoint value flashes

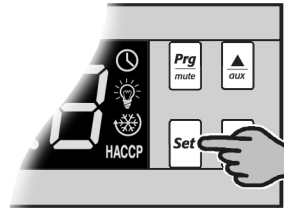

2. To adjust the setpoint: press either the $\frac{\Delta}{aux}$ and $\frac{def}{\nabla}$ keys to display the required setpoint value.

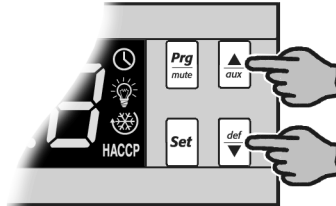

3. Press the **Set** key again to memorise the new setpoint value. If this is not done within 60 seconds, changes will be lost and you will need to repeat the above procedure.

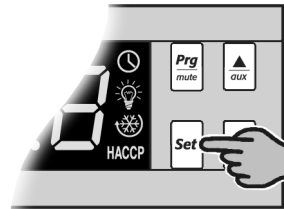

Controller Reset

To delete program modifications and reset the controller to SKOPE default program or when a replacement controller is being fitted, a 'Controller Reset' must be performed.

To reset the controller

1. Disconnect the cabinet from the power supply.

2. Press and hold the $\frac{Prg}{mute}$ key while plugging the cabinet into the power supply (may require two people). After a few seconds the program mode '**bn0**' is displayed. The controller must never be left in program mode '**bn0**' as failure will occur.

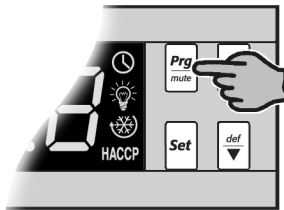



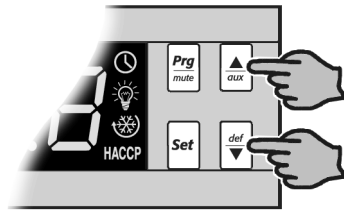



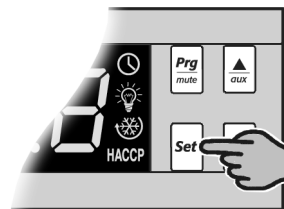



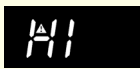



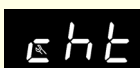







3. Press the $\frac{\Delta}{aux}$ or $\frac{def}{\nabla}$ keys to select **bn1** (SKOPE default program).

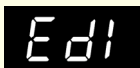
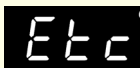

4. Immediately press the **Set** key to confirm the preferred program. If not confirmed within 60 seconds the cabinet will remain in program mode '**bn0**' (and cause failure). If this occurs, repeat the above procedure.

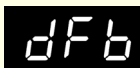

Controller Alarms

Code	Display	Buzzer	Alarm Description	Action
	 Flashing	on	Product HIGH temperature alarm (auto reset)	<ol style="list-style-type: none"> 1. Check the cabinet product loading to ensure ventilation slots are not blocked and that product does not overhang the shelves. 2. Ensure the cabinet is installed with good refrigeration unit ventilation. 3. If immediate alarm recovery is required - unplug the cabinet from the power supply for 1 minute, then reconnect to power supply. <p>If alarm persists, contact SKOPE.</p>
	 Flashing	on	Product LOW temperature alarm (auto reset)	
	 Flashing	off	Refrigeration system high temperature pre-warning (auto reset)	
	 Flashing	on	Refrigeration system high temperature shut-down (manual reset)	<ol style="list-style-type: none"> 1. Check refrigeration ventilation. Ensure clear airpath at the top and front of the cabinet (to extract hot air). A minimum of 200mm clear space is required above and in front of the refrigeration unit. 2. Ensure the cabinet is installed in a suitable environment. 3. To reset the 'CHT' alarm - unplug the cabinet from the power supply for 1 minute, then reconnect to power supply. <p>If alarm persists, contact SKOPE.</p>
	 Flashing	off	Ambient probe fault (also flashes 'rE')	<p>To reset alarm - unplug the cabinet from the power supply for 1 minute, then reconnect to power supply.</p> <p>If alarm persists, contact SKOPE.</p>
	 Flashing	off	Evaporator probe fault	
	 Flashing	off	Condenser probe fault	
	None	off	Defrost over-time limit	
	 Flashing	off	Real-time clock fault	
	 Flashing	off	Controller E prom error	
	 Flashing	off	Controller E prom error	
	None	-	Start defrost request	
	None	-	End defrost request	

3 Maintenance

Isolating Electrics

The chiller cabinet should be isolated from the power supply before attempting **any** maintenance.

Use the isolating switch and plug, located in the refrigeration unit compartment, to turn off the electrics to the cabinet and refrigeration unit without unplugging the cabinet from the wall.

To isolate the electrics

1. Remove the front panel from the cabinet by undoing the fixing screws near the bottom of the panel and lifting it up and off the cabinet.

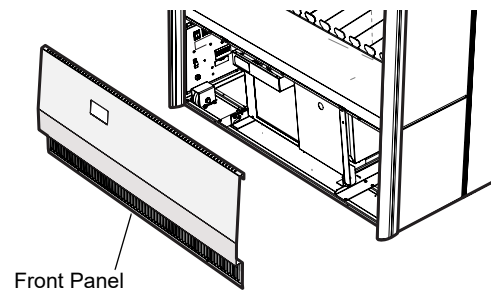

2. Switch off (O) the power at the mains isolation switch and unplug the mains IEC plug on the LH side of the refrigeration unit compartment.

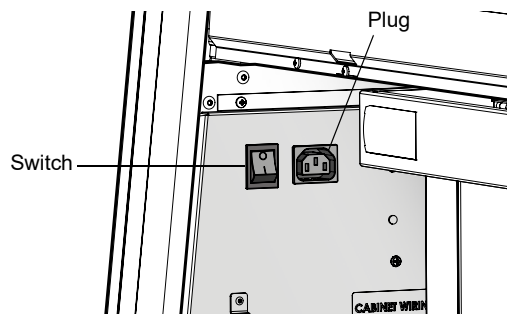

Maintenance

To ensure the chiller continues to run efficiently and reliably, the following maintenance should be carried out:

Cleaning Cabinet	<p>Keep the interior and exterior of the cabinet clean by regular wiping with a damp cloth.</p> <p>The bottom shelf can be removed to assist with cleaning by undoing the two side fixing screws. Ensure the bottom shelf is refitted before reconnecting the chiller to the power supply.</p> <p>Be careful not to wash any liquid down into the refrigeration system, as this could lead to refrigeration failure.</p>
Cleaning Condenser Coil	<p>The condenser coil must be cleaned at least monthly with a soft brush to remove dust and fluff (see instructions below).</p>
Regular Servicing	<p>A thorough service clean must be completed by qualified service personnel every six months.</p>
Time Frames	<p>Time frames specified above are indicative only. More regular cleaning and servicing may be required depending on chiller placement and operating environment.</p>

To clean the condenser coil

1. Remove the front panel and isolate the chiller from the power supply (see page 16).

2. Brush the condenser coil with a soft brush

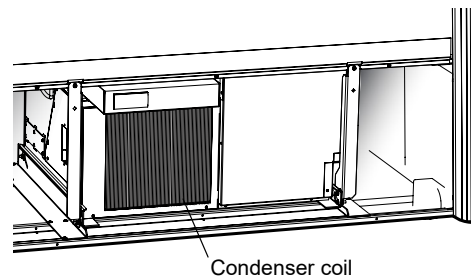

3. Refit the front panel and reconnect to the power supply.

WARNING

Disconnect the chiller from the power supply before cleaning the condenser coil.

Troubleshooting

For questions about the electronic controller, see page 11. For problems with the cabinet and refrigeration cassette, use the following table.

Problem	Possible Cause	Suggestions
<ul style="list-style-type: none"> • Chiller not operating • No controller display 	<ul style="list-style-type: none"> • Loss of power supply • Isolating switch turned off 	<ul style="list-style-type: none"> • Check mains power supply. • Check isolating switch (see page 16).
<ul style="list-style-type: none"> • Lights not on 	<ul style="list-style-type: none"> • Night blind is down • Light switched off • Lighting fault • Blown cabinet fuse 	<ul style="list-style-type: none"> • Raise the night blind. • Switch light on at electronic controller faceplate (see page 12). • Arrange a service call. • Arrange a service call.
<ul style="list-style-type: none"> • Power consumption is higher than expected 	<ul style="list-style-type: none"> • Refrigeration unit operating too hot 	<ul style="list-style-type: none"> • Clean the condenser coil (see page 17). • Ensure the cabinet has good ventilation around the refrigeration unit (see page 5). • Ensure the cabinet is installed in a cool location within operating specifications (see page 5).
<ul style="list-style-type: none"> • Product is too warm 	<ul style="list-style-type: none"> • Restricted airflow to cabinet 	<ul style="list-style-type: none"> • Ensure product is not blocking airflow slots. • Ensure there is space around individual product pieces.
<ul style="list-style-type: none"> • Warm cabinet temperatures • Compressor operating for long periods (more than 1 hour) 	<ul style="list-style-type: none"> • Blocked condenser • Poor ventilation around refrigeration cassette 	<ul style="list-style-type: none"> • Clean the condenser coil (see page 17). • Ensure the cabinet is installed in a cool location within operating specifications (see page 5).

SKOPE Industries Limited

A.B.N. 73 374 418 306

AU: 1800 121 535

NZ: 0800 947 5673

skope@skope.com

www.skope.com

Trademark Infringement

The SKOPE and Centaur trademarks on this product are infringed if the owner, for the time being, does any of the following:

- Applies the trade mark to the product after their state, condition, get-up or packaging has been altered in any manner
- Alters, removes (including part removal) or obliterates (including part obliteration) the trade mark on the product
- Applies any other trade mark to the product
- Adds to the product any written material that is likely to damage the reputation of the trade mark

Notice of the above contractual obligations passes to:

- Successors or assignees of the buyer
- Future owners of the product

OD460
SKOPE Open Deck Chiller
User Manual
MAN11106
Rev. 2.1 May 2020

© 2015 SKOPE Industries Limited. All rights reserved.
SKOPE Industries Limited reserve the right to alter specifications without notice.

SKOPE is a registered trademark of SKOPE Industries Limited.